

PRODUCT CODE 92111

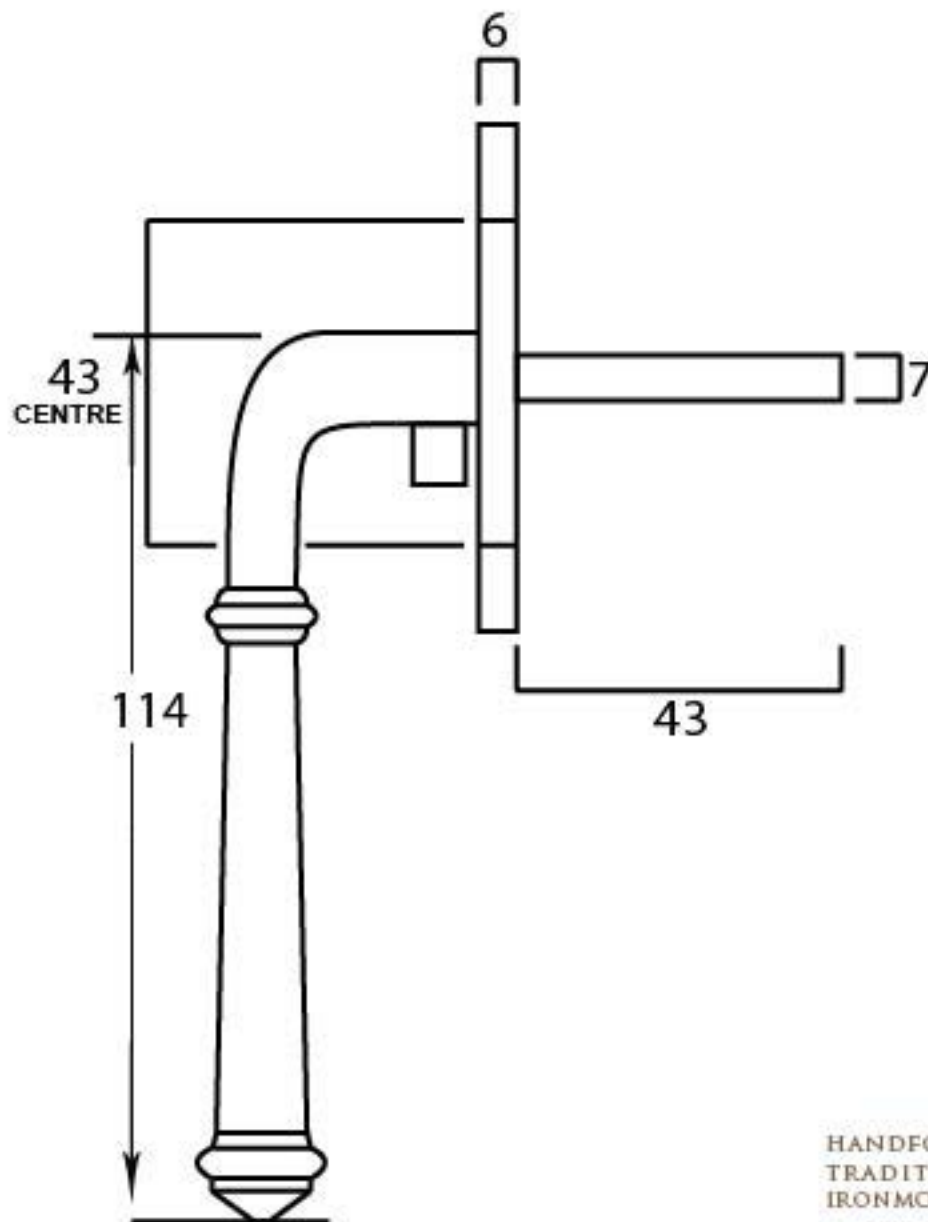

M5 x 40 Machine Screws

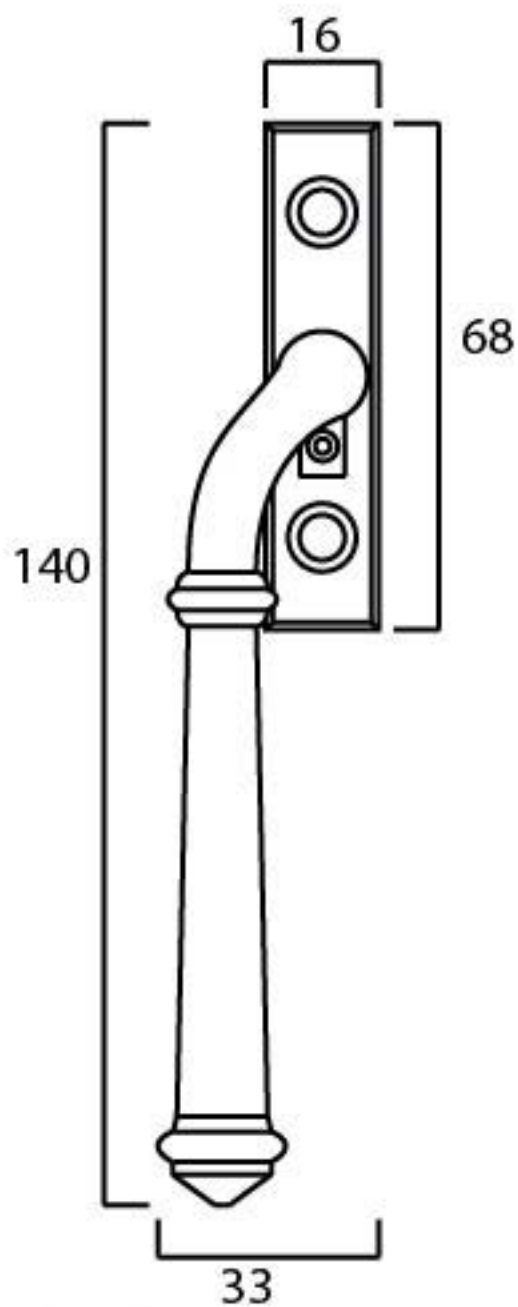

HANDFORGED
TRADITION L
IRONMONGERY



Due to the hand crafted nature of our products all measurements are approximate and should be used as a guide only